

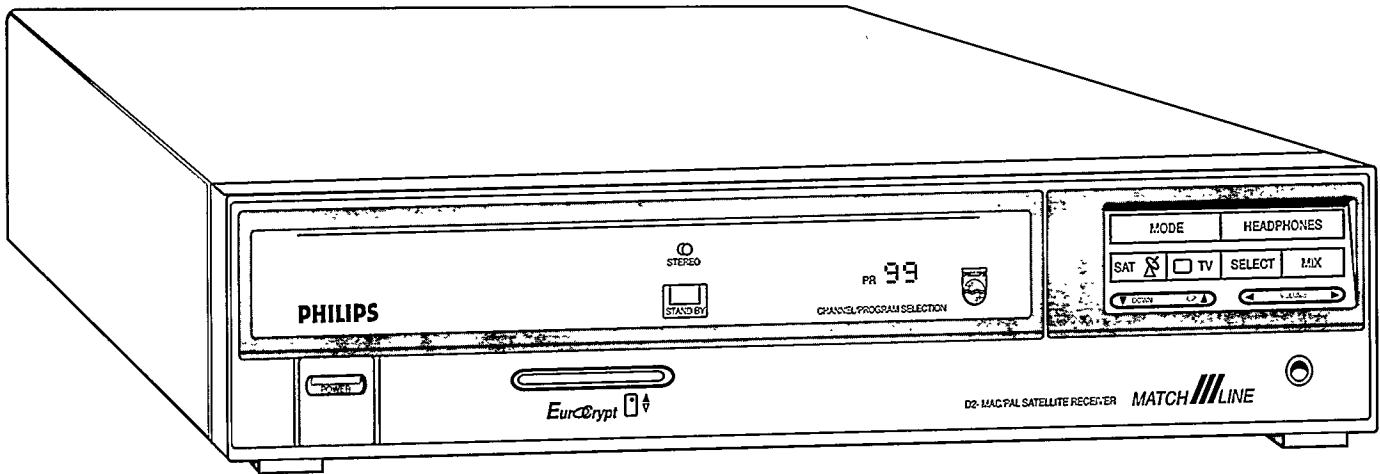

CONSUMER ELECTRONICS

PHILIPS

D2 **MAG**



STU 901

SATELLITE RECEIVER
SATELLITTUNER
SATELLIT TUNER
SATELLITMOTTAKER

GB OPERATING INSTRUCTIONS

Attention! Open this front flap to see diagrams of your Receiver and its Remote Control.

Open the rear flap to see how to use the On-Screen-Displays (OSD).

S BRUKSANVISNING

OBS! Vik alltid ut denna flik samtidigt som du läser bruksanvisningen.

Vik även ut den sista fliken, där det beskrivs hur du använder On-Screen-Display (OSD).

DK BETJENING

Bemærk! Åben denne folde-ud side for at kunne se oversigterne på Deres modtager og dens fjernbetjening.

Åben den bageste folde-ud side for at se hvorledes On-Screen-Display (OSD) benyttes.

N BRUKSANVISNING

OBS! Brett ut første side for å se tegningene over mottakeren og fjernkontrollen.

Brett ut siste side for å se hvordan " On-screen displayene" (OSD) brukes.

STU 901 SATELLITE TELEVISION UNIT

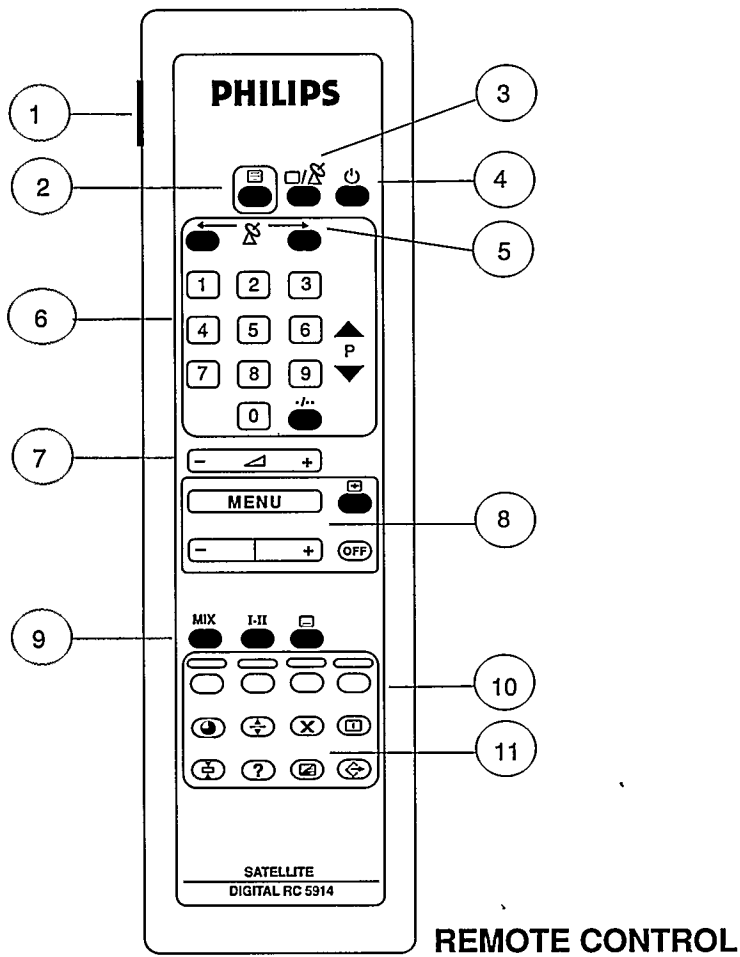

RECEIVER

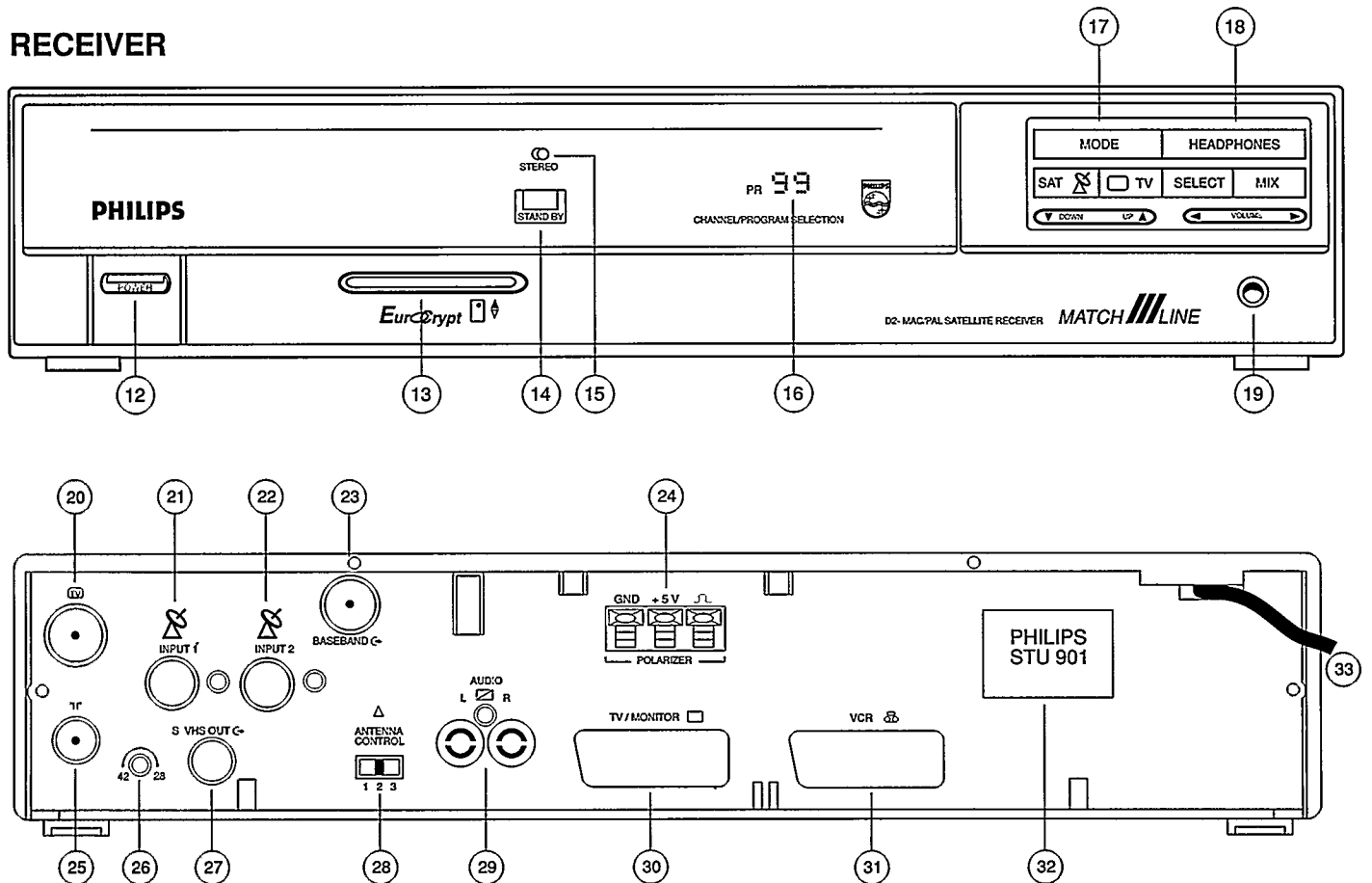

LEGEND

REMOTE CONTROL

- 1 Remote control for Philips TVs
- 2 Teletext on/off
- 3 TV/SAT selection
- 4 Standby (Off)
- 5 Antenna positioning
- 6 Numeric keypad
- 7 TV set volume
- 8 Menu buttons for On-Screen-Displays
- 9 Sound mixing and subtitling
- 10 (these buttons not used)
- 11 Teletext buttons

RECEIVER FRONT PANEL

- 12 POWER ON/OFF
- 13 Slot for EuroCrypt Card
- 14 Standby indication
- 15 Stereo indication
- 16 Programme number indication
- 17 Programme controls
- 18 Headphone controls
- 19 Headphone socket

RECEIVER REAR PANEL

- 20 TV antenna connection - out
- 21 Satellite dish 1 input
- 22 Satellite dish 2 input
- 23 Baseband decoder output
- 24 Polarizer connections
- 25 TV antenna or cable connection
- 26 Tuning control
- 27 S-VHS recorder connection
- 28 Antenna power control
- 29 Audio amplifier connections
- 30 Euroconnector for TV/monitor
- 31 Euroconnector for VCR
- 32 Type & voltage plate
- 33 Mains cable

CONTENTS

1. BEFORE YOU START			
General	2		
Safety instructions	2		
Mains connection	2		
2. HOW TO CONNECT YOUR RECEIVER			
Position your STU 901 Receiver	3		
Insert batteries in the remote control	3		
Connect your satellite dish antenna	3		
Connect your Receiver:	3		
A. To a TV only, using a Euroconnector	3		
B. To a TV only, using a coaxial cable	4		
C. To a TV and a VCR, using Euroconnectors	4		
D. To a TV and a VCR, using coaxial cables	5		
E. To a TV and an S-VHS VCR	5		
Connect the Polarizer (if applicable)	6		
Aim your dish	6		
Adjust the Polarizer	6		
Additional connections	6		
Filmnet decoder	6		
3. HOW TO WATCH SATELLITE TV			
Switch on/Switch off	7		
Select a programme	7		
Change the sound volume	7		
The TV/SAT button	7		
Control your Philips TV remotely	7		
The MENU buttons on your remote control	7		
Check which programme you are viewing (D2-MAC)	8		
Selecting other transmitted languages (D2-MAC)	8		
Mix mode (D2-MAC)	8		
Switching on subtitles (D2-MAC)	8		
Selecting other transmitted subtitles (D2-MAC)	8		
Display the time (D2-MAC)	9		
View D2-MAC Teletext	9		
Use headphones (optional)	9		
Record programmes on your VCR	9		
Record laserdisk programmes on your VCR	10		
Playback from a VCR	10		
4. PARENTAL CONTROL & CONDITIONAL ACCESS			
Introduction		10	
Using the Parental lock		10	
What is Parental Control?		10	
How to change your Secret Code		11	
How to check the current Parental Control setting		11	
How to change and lock the Parental Control setting		12	
What is Conditional Access (CA)?		12	
How to watch an encrypted programme		12	
Using the EuroCrypt Card		12	
How to use Consultation		13	
To see your Subscription details		13	
To see Prebooked Pay Per View details		13	
To see Impulse PPV per program details		14	
To set the Consultation lock		14	
To set the Pay Per View lock		14	
To view Impulse Pay Per View programmes		14	
Renewing your authorisation		15	
5. 'PERSONALISING' YOUR RECEIVER			
Introduction		16	
Changing the menu language		16	
Adjusting the picture		16	
Changing colour saturation and contrast (D2-MAC programmes only)		16	
Changing the picture display format		17	
Changing your preferences for D2-MAC sound		17	
Changing your preferences for D2-MAC subtitling		18	
Sound selection with PAL/SECAM programmes		18	
Introduction to programming		18	
Search for a station...		19	
... or Direct Channel Selection		19	
Give it a programme number		19	
Naming a station		19	
To check the programme list		19	
Storing a station		20	
Notes		20	
Using Teletext (D2-MAC only)		20	
Introduction		20	
Switching on Teletext		20	
Selecting a Teletext page		20	
To switch off Teletext temporarily		20	
To select double height text		20	
To show concealed information		20	
To stop automatic page changes (of 'rotating' pages)		20	
To see Teletext and a TV programme simultaneously (D2-MAC only)		20	
To quit Teletext		20	
To store Teletext personal preference pages		20-21	
6. SPECIFICATION			22
7. FAULT FINDING			23

General

With this Philips STU 901 Satellite Receiver you can receive satellite programmes broadcast in the PAL/SECAM and D2-MAC transmission standards.

The operation of the Receiver differs slightly depending on whether you are receiving PAL/SECAM or D2-MAC signals.

Both are covered in these instructions.

The drawings in the text are accompanied by numbers in brackets, e.g.(1) These correspond to the numbers on the drawings on the front fold-out flap. Bold numbers without brackets - like this **1** - refer to numbers on the remote control keypad (6).

Fold out the rear flap to see how to use the on-screen displays.

Safety Instructions

To avoid short-circuits, which may cause fire or electric shock, do not expose this Philips STU 901 Satellite Receiver to rain or moisture.

Dangerous voltage inside. Do not open the cabinet.

There are no user serviceable parts inside.
Repairs should be carried out by qualified service personnel only.

NEVER connect or modify cables while the Receiver is connected to the mains. Switch off using switch (12).

Ensure that no objects or fluids pass through the ventilation openings.

If liquid is spilt into the Receiver, disconnect the Receiver from the mains and consult a qualified service technician.

Do not put your Receiver close to an external source of heat (radiator, etc.).

Ensure that air can circulate freely through the ventilation openings of the Receiver.

Avoid using the Receiver on soft surfaces or near appliances generating strong magnetic fields (e.g. motors, transformers).

Do not use your Receiver in dusty places or where it may be subject to vibration.

Avoid using your Receiver immediately after moving from a cold to a warm location and vice versa, or under conditions of high humidity.

If you have to transport your Receiver, avoid violent shocks.

Your Receiver supplies 14 or 18 V DC voltage to your satellite dish antenna.

Make sure you only connect your satellite dish to the satellite dish inputs, (21 and 22) and nothing else.

For cleaning, use a damp chamois leather - never use an abrasive.

Mains connection

Before connecting the Receiver to the mains, check that the mains supply voltage corresponds to the voltage printed on the type plate (32) on the rear panel of your Receiver.

If the mains voltage is different, consult your dealer.

Do not connect the Receiver to the mains yet, but continue reading these Operating Instructions!

NEVER connect or modify cables while the Receiver is connected to the mains. Ensure that the mains plug is not plugged in to the mains supply before proceeding further.

Position your Philips STU 901 Satellite Receiver

The STU 901 is intended for use in a domestic environment only and should never be operated or stored in excessively hot or humid atmospheres.

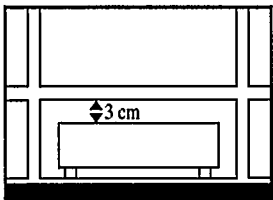

Choose a position at some distance away from radiators or other sources of heat.

Leave a clear space of at least 3 cm all around the set for ventilation. Make sure that curtains, cupboards, etc. cannot obstruct air flow through the ventilation openings.

Insert batteries in the remote control

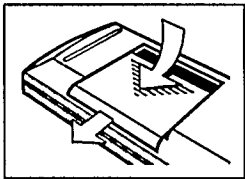

Remove the battery cover located on the back of the remote control handset.

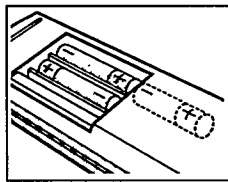

Insert three batteries (type R03S 1.5 V). Replace the battery cover.

Connect your satellite dish antenna

First, install the dish antenna and its receiving element - the Low Noise Converter (LNC) - according to the manufacturer's instructions.

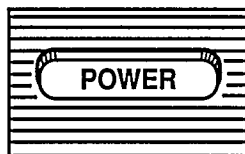

You must only set the Antenna Control (28) to the required position when the Receiver is switched off.

If necessary, press POWER (12) to switch the Receiver off.



Position 1

No power is supplied to the LNC! Use this position if the distance (cable length) between the Receiver and the dish antenna is more than 30 meters. You may need an extra amplifier in the cable from your Receiver to the dish - ask your dealer for advice.

Position 2

If you have one or two LNCs. This is the usual situation. In this case, the Receiver supplies the LNC via the cable (14 or 18 V, 300 mA max).

Position 3

Not used.

Connecting your Receiver

This section tells you how to connect the Philips STU 901 Satellite Receiver to the equipment you already have, such as a TV and Video Cassette Recorder (VCR).

There are many connection options of which the most common are:

- To a TV only, using a Euroconnector.
- To a TV only, using a coaxial cable
- To a TV and a VCR, using Euroconnectors
- To a TV and a VCR using coaxial cables
- To a TV and an S-VHS VCR

Option A is the best if you have a TV only because it gives the best picture and sound quality - especially with D2-MAC programmes. You will obtain even better sound if you connect the Receiver to your hi-fi system.

See **Additional Connections** below.

Select one of the connection options, then follow the step-by-step instructions below :

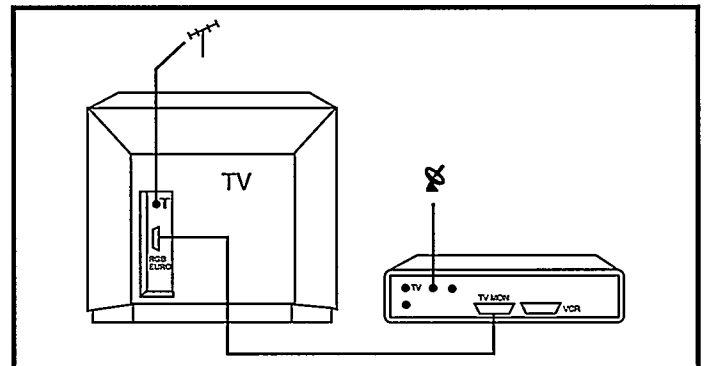

A. To a TV only, using a Euroconnector

- Make the connections as shown in the drawing using the Euroconnector supplied with your Receiver.
- Connect your Receiver to the mains socket.
- Switch your TV ON.
- Switch your Receiver ON (12)
- Press button number 0 on the Receiver remote control (6). The programme number indicator (16) on your Receiver will show 0. Press the MENU button (8) on the remote control. You should now see the MAIN MENU on your screen (see rear flap). If not, you may have to select the A/V input on your TV.
- Press MENU OFF and go to the section **Aim your dish**.

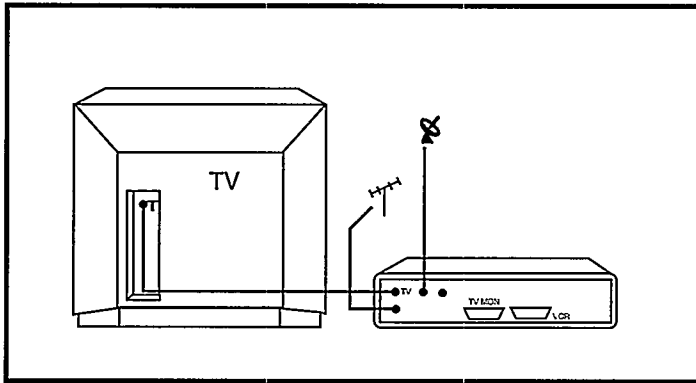

B. To a TV only , using a coaxial cable

1. Make the connections as shown in the drawing using the coaxial cable supplied with your Receiver.
2. Connect your Receiver to the mains socket.
3. Switch your TV ON.
4. Switch your Receiver ON (12)
5. Press button number 0 on the Receiver remote control (6). The programme number indicator (16) on your Receiver will show 0. Press the MENU button (8) on the remote control.
6. Switch your TV to each of its programme numbers in turn to check that your Receiver is not causing interference with normal programmes.
7. If there is patterning, or any other interference on the screen, adjust the TUNE control (26) on the back of the Receiver until you have a good picture. Only a small adjustment, sufficient to remove the patterning, should be made at a time.
8. Continue this procedure until you have checked all the programme numbers on your TV.
9. Select a spare programme number on your TV which you will always use for satellite programmes - this is now your 'Satellite Receiver number'. Tune your TV until you find a picture from the Receiver. You will know that you are looking at a picture from the Receiver when you see the MAIN MENU appear on your TV screen (see rear flap).
10. If the reception is poor, use a small screwdriver to turn the TUNE control (26) on the Receiver until the reception is good. Go back to Step 6.
11. Go to the section Aim your dish.

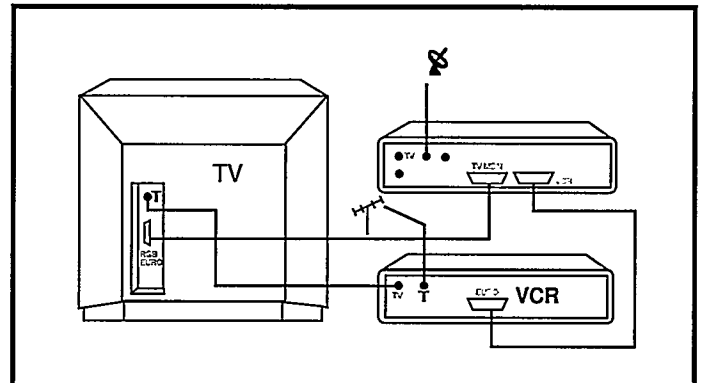

C. To a TV and a VCR , using Euroconnectors

1. Make the connections as shown in the drawing.
2. Connect your Receiver to the mains socket.
3. Switch your TV ON.
4. Switch your Receiver ON (12)
5. Press button number 0 on your Receiver remote control (6). The programme number indicator (16) on your Receiver will show 0. Press the MENU button (8) on the remote control. You should now see the MAIN MENU on your screen (see rear flap). If not, you may have to select the A/V input on your TV.
6. Switch the Receiver to Standby using button (4). Play a video cassette in your VCR. If you do not see a picture from the VCR, check the connections as above.
7. Switch your VCR off.
8. Press 0 on your Receiver remote control, press MENU and go to the section Aim your dish.

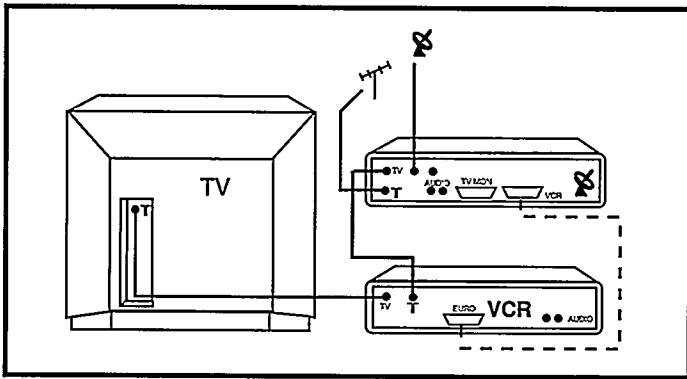

D. To a TV and a VCR , using coaxial cables

1. Make the connections as shown in the drawing using the cable supplied with your Receiver.
2. Connect your Receiver to the mains socket and switch ON (12).
3. Switch your TV ON.
4. Switch your VCR ON.
5. Press button number **0** on your Receiver remote control. The programme number indicator (16) on your Receiver will show **0**. Press the MENU button (8) on the remote control.
6. Switch your TV to each of its programme numbers in turn to check that your Receiver is not causing interference with normal programmes.
7. If there is patterning, or any other interference on the screen, adjust the TUNE control (26) on the back of the Receiver until you have a good picture. Only a small adjustment, sufficient to remove the patterning, should be made at a time.
8. Continue this procedure until you have checked all the programme numbers on your TV.
9. Select a spare programme number on your TV which you will always use for satellite programmes - this is now your 'Satellite Receiver number'. Tune your TV until you find a picture from the Receiver. You will know that you are looking at a picture from the Receiver when you see the MAIN MENU appear on your TV screen (see rear flap).
10. If the reception is poor, use a small screwdriver to turn the TUNE control (26) on the Receiver until the reception is good. Go back to Step 6.
11. On your TV, select the programme number you use to watch your VCR.
12. Select a spare programme number on your VCR which you will always use for satellite programmes. It is a good idea to use the same programme number as your TV 'Satellite Receiver number'.
13. Tune your VCR until you find a picture from the Receiver. You will know that you are looking at a picture from the Receiver when you see the MAIN MENU appear on your TV screen (see rear flap).

14. If there is patterning, or any other interference on the screen, adjust the TUNE control (26) on the back of the Receiver until you have a good picture. Only a small adjustment, sufficient to remove the patterning, should be made at a time.
Now check all the VCR programmes for possible patterning. Select your Satellite Receiver number on your TV and check again the TV programme for possible patterning. If a problem occurs, go back to step 7.

15. Go to the section **Aim your dish**.

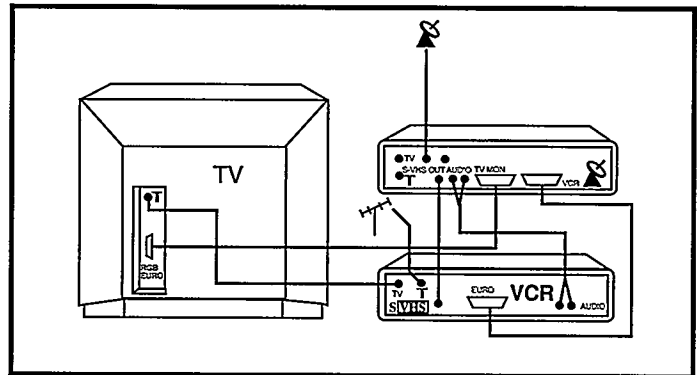

E. To a TV and an S-VHS VCR

1. Make the connections as shown in the drawing.
2. Connect your Receiver to the mains socket.
3. Switch your TV ON.
4. Switch your Receiver ON (12)
5. Press button number **0** on your remote control (6). The programme number indicator (16) on your Receiver will show **0**. Press the MENU button (8) on the remote control. You should now see the MAIN MENU on your screen (see rear flap). If not, you may have to select the A/V input on your TV.
6. Switch the Receiver to Standby using button (4). Play a video cassette in your VCR. If you do not see a picture from the VCR, check the connections as above.
7. Press **0**, then MENU on your Satellite Receiver remote control and go to the section **Aim your dish**.

NOTE:

Only D2-MAC programmes will be recorded via the S-VHS connection; PAL/SECAM programmes will only be recorded via the Euroconnector between your Satellite Receiver and your VCR.

Connect the Polarizer (if applicable)

Signals from a satellite are transmitted with different polarizations. There are 4 kinds of polarizations:

Direct Broadcast Satellites DBS (TV satellites like TDF and TELE-X) transmit with circular polarization: left hand circular = L, or right hand circular = R.

All other satellites (such as ASTRA) transmit with linear polarization: horizontal = H or vertical = V.

For proper reception, you need a device called a Polarizer which is located in the LNC assembly of your dish antenna. This must be connected to the STU 901 so that the right polarization is selected automatically each time you change channels.

To make this happen, connect the 3 small leads from your antenna cable to the POLARIZER connectors (24) on the back of your Satellite Receiver:

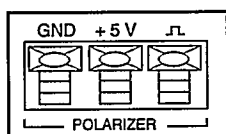

- the black lead to GND
- the red lead to +5 V
- the white lead to \square (pulse)

Aim your dish

Check that you still have the MAIN MENU on your screen (see rear flap). If not, follow the first steps for the Connection Option you have chosen. Press MENU OFF on your remote control.

Consult the Satellite Programme Guide supplied with your Receiver and choose a programme number on the satellite at which you will aim your dish, eg TV3, Programme 3, on ASTRA 1-A; RTL plus, Programme 37, on TV-SAT2 etc

Now install your dish following the instructions supplied with the dish. If you cannot obtain a satisfactory picture, see Section 7, "FAULT FINDING".

Adjust the Polarizer

- select the Programme Number you want to optimise
- press the MENU button (8) on the remote control
- press 7 to select INSTALLATION
- press 2 to select SATELLITE PROGRAMMES
- press 2 to select ANTENNA SETTINGS
- if necessary, press 2 for SELECT POLARISATION and use - + to highlight the polarization for the programme you have selected (see your Satellite Programme Guide)
- press 3 to select ADJUST POLARISATION (the menu disappears)
- use - + to get the best picture (as you press - +, look at the Programme Number Indication (16), you will see changing numbers from 0 to 20)
- press MENU twice to return to SATELLITE PROGRAMMES
- press 7 to **STORE your settings**
- press MENU OFF

NOTE:

With single reflector satellite dishes, the SELECT POLARISATION settings LEFT and RIGHT may need to be reversed i.e. if the correct setting is LEFT, you may need to select RIGHT.

The preset values have been set for the Philips High Performance dual reflector antenna.

Additional connections

AUDIO L / R (29)

If you wish to use your hi-fi installation to listen to satellite programmes then you must connect it to the audio sockets (29). These sockets are also used to connect an S-VHS recorder.

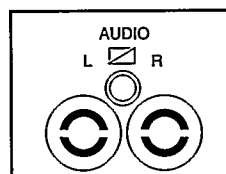

- Connect the output sockets AUDIO L (left channel) and AUDIO R (right channel) to a pair of left and right input sockets on your hi-fi installation. If you have a Filmnet decoder, connect AUDIO L to AUDIO IN of that decoder.

DO NOT connect AUDIO L / R to the PHONO sockets of your hi-fi installation.

Filmnet DECODER

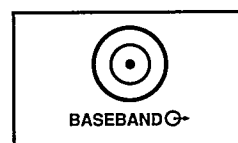

- If you have a Filmnet decoder, connect BASEBAND (23) to VIDEO IN of the Filmnet decoder. (The antenna output of the Filmnet decoder should be used for connection to your TV or VCR).

For normal viewing, your Philips STU 901 Satellite Receiver is operated entirely from its remote control unit.

The following instructions are for 'normal operation' - to get you started quickly - and assumes that you are happy with all the factory-set conditions. If you wish to change any of these later, go to Section 5 "PERSONALISING YOUR RECEIVER"

You will find it helpful to fold-out the flaps at the front and rear of this manual. The front flap contains drawings of your Receiver and gives the numbers used in these instructions. The rear flap shows you how to use the on-screen displays.

Switch on

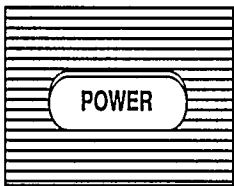

Have you connected your system correctly, following the instructions in Section 2? If so, proceed as follows: Press the POWER switch on the Receiver (12). If you do not get good reception, see 'Poor reception' in the Section 7 "FAULT FINDING"

Switch off

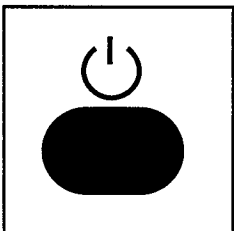

Press the stand-by switch (4) on your Receiver Remote Control. This puts the Receiver in standby mode enabling you to switch it on again directly from the remote control. The power consumption in standby mode is very low - only 7 W.

(NB. You should not leave the Receiver in standby mode if your home is empty for long periods or during thundery weather.)

Select a programme

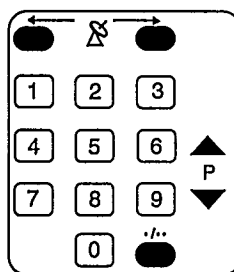

Press any of the buttons in group (6). To select programmes 1 to 9, press the number only; to select programmes from 10 to 99, first press the button ./. ., then the first digit followed by the second digit. For example, to select programme 34, press ./. . followed by 3 and 4.

Once you are in "two-digit mode", you will not need to press the ./. . button again to select numbers from 10 to 99. To return to "single digit mode", press the ./. . button again.

You can "zap" from programme to programme using the "P" buttons.

Change the sound volume

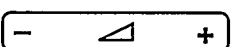

If you have a Philips TV you may be able to control the volume of the sound with your Receiver remote control, (7). This may not be possible with some older Philips TV sets. With most other makes of TV sets the volume button on your Satellite Receiver Remote Control will have no effect.

The TV/SAT button (3)

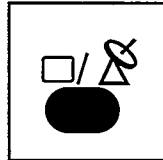

With some TV sets it may be impossible to select a normal TV programme while the Receiver is switched on. This may happen when you have your Receiver connected to your TV by means of an A/V connector cable.

If this occurs, you should press the TV/SAT button (3) on your Remote Control **once**. Now you can select and watch normal TV programmes.

To return to satellite programmes, press the TV/SAT button (3) **once** again.

If you have no problem changing TV channels while your Receiver is switched on, you will not need to use the TV/SAT button.

Control your Philips TV remotely

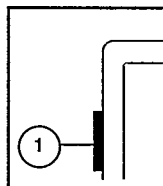

At the top left side of your Receiver Remote Control unit is a hidden switch (1). If you press this in, and continue to hold it down, your Receiver Remote Control can act as a TV remote control for Philips TVs. You can then change TV programmes by pressing the programme numbers on the Receiver Remote Control (6).

This function may not work with some older Philips TV sets.

The MENU buttons on your remote control (8)

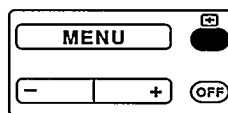

The MENU buttons, located in the red field (8) on your Remote Control let you control a number of additional features of your Receiver. For example, they enable you to adjust the picture contrast settings.

See Section 5 "PERSONALISING YOUR RECEIVER" for more details.

The MENU buttons are used to select the On-Screen-Displays (OSD).

Check which programme you are viewing (D2-MAC)

To check which programme you are viewing, press the ⊕ button in the MENU area (8). The display, shown here, will appear at the top right of your TV picture. This display will not appear if you have switched on subtitles.



Press the ⊕ button (8) again to switch off the programme indication.

Selecting other transmitted languages (D2-MAC)

- press the MENU button (8) on the remote control
- press 2 to select SOUND
- press 1 - 8 for the language you want
- press MENU OFF

You can also select the transmitted sound simply by pressing the I-ll button on the remote control several times.



Mix (D2-MAC)

In the MIX mode, you can listen to a second sound in addition to the main sound, if the transmitted signal makes this possible, for example the broadcast of a football match. You can then hear the 'original' noise of the crowd mixed with the voice of the commentator in your language .

To do this, select menu item 9 MIX and highlight ON by pressing the - + key.



Switching on subtitles (D2-MAC)

- press the ⊖ button in section (9) on your remote control. Your most preferred subtitles transmitted will appear on the screen after a few moments. If you want to change your preferred subtitles see section 5 "Changing your preferences for D2-MAC subtitling" .

- press the ⊖ button again to switch the subtitles off.

If you would like to have subtitles automatically appear (if transmitted), do the following:

- press the MENU button (8) on the remote control
- press 6 to select SPECIAL FEATURES
- press 3 to select CONTINUOUS SUBTITLING
- press + to select ON (if necessary)
- press MENU OFF

In this case the ⊕ button (8) will not react, because priority is given to subtitles, even if no subtitles are transmitted.

Selecting other transmitted subtitles (D2-MAC)

This procedure is similar to "Selecting other transmitted languages" .

- press the MENU button (8)
- press 3 to select SUBTITLE
- press 1 to 8 for the language you want
- press MENU OFF

Display the time (D2-MAC)



Press the clock button on the Teletext controls (11). If transmitted, the correct time will appear at the top right of your TV picture. Press the clock button again to switch it off.

View D2-MAC Teletext



You can watch Teletext pictures from a D2-MAC satellite transmission whether or not your TV has a Teletext function built-in. With PAL/SECAM satellite broadcasts, you can only watch Teletext transmissions if you have a TV set fitted with Teletext.

If you are watching a D2-MAC programme you can view Teletext by pressing button (2). You then change pages by using the keypad buttons in (6). Press button (2) again to switch off the D2-MAC Teletext function.

For more information on using Teletext, please refer to the item "USING TELETEXT" in Section 5, "PERSONALISING YOUR RECEIVER"

Use headphones (optional)

You can use headphones to listen to satellite TV and radio programmes.



Connect a stereo headphone with an impedance from 8 to 600 Ohm and a 6.3 mm jack-type plug into socket (19).

Press VOLUME (18) to adjust the sound level.

With D2-MAC programmes, you can change and mix the sound signals available:

- press SELECT to choose the headphone language.
- press MIX to select mixed or unmixed mode. (this is to select a combination of the various sound signals available - such as background and commentary).

With PAL programmes, you can only Select in the MONO mode (when the green Stereo light (15) is out). Mix has no function.

Recording programmes on your VCR

You can record programmes from non-satellite sources just as you have always done; but there are some differences when recording satellite programmes.

You can use your VCR to record satellite TV programmes in three main ways:

- to record a satellite programme while you watch it
- to record a satellite programme while watching another TV programme (not another satellite programme).
- to record a satellite programme while the TV is switched off

In all cases, select the satellite programme you want to record on your Receiver. If you are not using Euroconnectors, switch your VCR to your "Receiver number" as described earlier in the "HOW TO CONNECT YOUR RECEIVER" section.

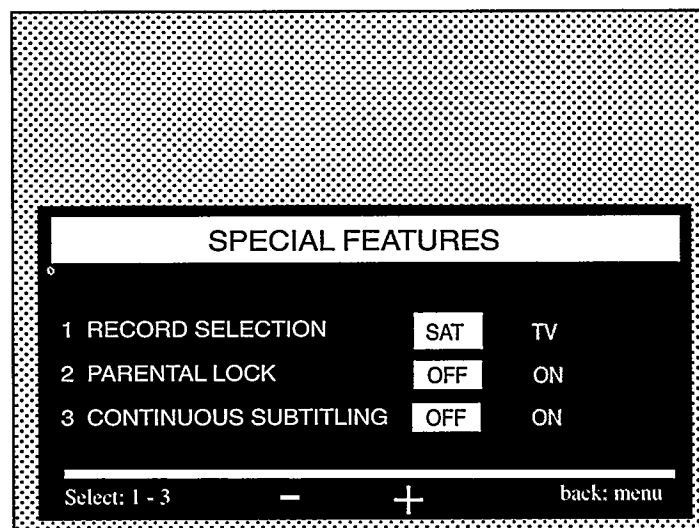
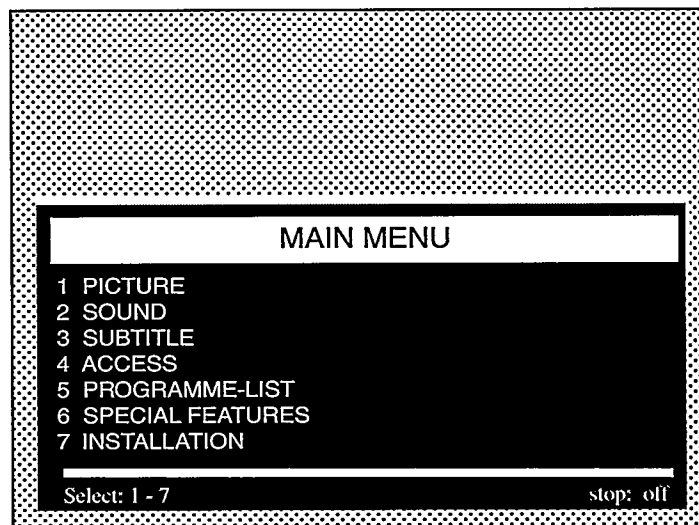

- press the MENU button (8) on the remote control
- press 6 to select SPECIAL FEATURES
- press 1 to select RECORD SELECTION
- press - to select SAT (if necessary)
- press MENU OFF

Now follow your usual recording procedure.

If you wish, you can now watch another TV programme or switch your TV off.

Record LaserDisk programmes on your VCR

(when a LaserDisk player is connected to the second Euroconnector socket on your TV)

- press the MENU button (8) on the remote control
- press 6 to select SPECIAL FEATURES
- press 1 to select RECORD SELECTION
- press + to select TV

Now follow your usual recording procedure.

Playback from a VCR

- Press POWER (12) to switch the STU 901 on.

If you have made all connections using coaxial cables, just select on your TV your 'VCR programme number'.

If you have used Euroconnectors, the following may be the case: If you are watching the STU 901 picture, this picture will disappear and you will see the picture of the VCR automatically.

When you stop the VCR, the STU 901 picture will return.

If the STU 901 is in standby, also then the picture of the VCR will arrive on your screen automatically. If not, you may have to select the A/V input on your TV.

NOTE:

If power (12) is switched off, you will not be able to watch your VCR, assuming you made the connections as mentioned in the section 2 'HOW TO CONNECT YOUR RECEIVER'.

Introduction

Modern satellite TV programmes not only give you greater choice and better sound and pictures - with D2-MAC - they also offer you many improvements to make viewing more pleasurable and to give you greater control over what you watch. The key element are Parental Control and Conditional Access.

In all cases, you make extensive use of the On-Screen-Display (OSD) functions of the Receiver. All changes are made using the MENU buttons and the On-Screen-Displays. This makes the procedures fast and easy.

Study the diagram on the rear flap and the explanations carefully. You will then be able to make any changes you want simply by following the instructions in the various OSD menus.

Using the Parental Lock

If you want your children only to watch one specific programme, you can set the Receiver to show that programme only - Children's Channel, for example.

To set the Parental lock,

- first select the programme to lock using the button (6) on the remote control
- press the MENU button (8) on the remote control
- press 6 to select SPECIAL FEATURES
- press 2 to select PARENTAL LOCK
- press + to select ON
- press MENU OFF

The programme number cannot now be changed on the Receiver itself but can, of course, be changed using the remote control. To prevent this, take the remote control with you or hide it in a secure place.

The Parental Lock works with all programmes - D2-MAC, PAL and SECAM - whether they are encrypted or not. You do not need a EuroCrypt card to use the Parental Lock.

What is Parental Control?

The Receiver 901 has a Parental Control mode which you can use to stop your children watching certain types of programmes.

Many satellite programme providers rate programmes by their contents of sex, violence etc and transmit Parental Code Numbers with their encrypted D2-MAC transmissions. The STU 901 can detect these numbers - and lets you programme your Receiver so your children only watch programmes you think are suitable.

Movies are often rated according to their suitability for particular age groups:

- U = Universal
- PG = Parental Guidance
- 12, 15 and 18 = suggested viewing ages.

You can stop your children watching certain categories by using a Secret Code.

Parental Control works only with D2-MAC encrypted programmes for which you have a EuroCrypt card and when the broadcaster transmits Parental Code Numbers.

When first delivered, a EuroCrypt card is able to receive all programmes without restriction and the Secret Code is preset to 0000.

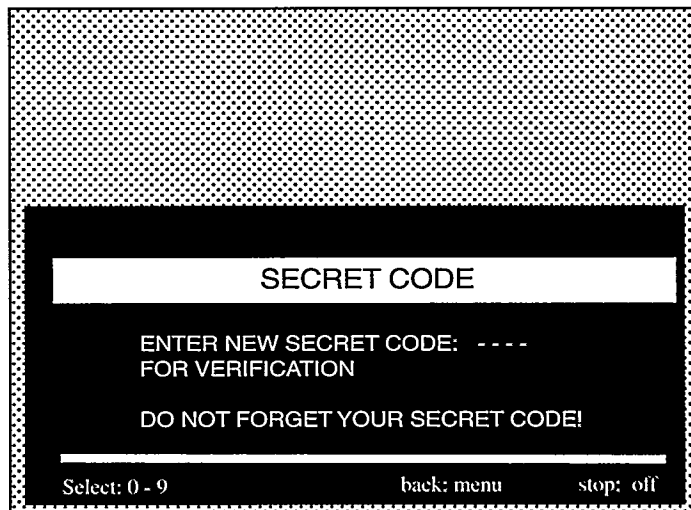
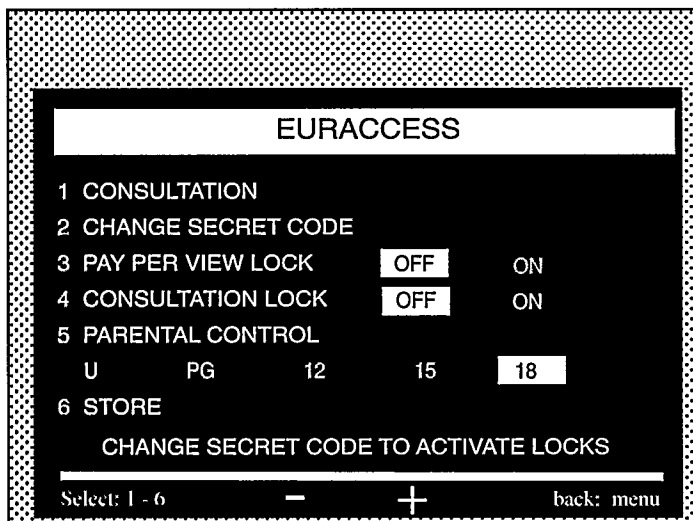

Do not forget your Secret Code! If you do, you will have to contact your dealer or the programme provider for assistance.

NOTE:

The factory pre-set code of 0000 means that there is no Secret Code in the Eurocrypt card. Once you change this, no-one can change (store) any locks or change the parental control settings without knowing your Secret Code.

How to change your Secret Code

Insert a EuroCrypt card into slot (13) at the front of your Receiver.

To change your Secret Code,

- press the MENU button (8) on the remote control
- press 4 to select ACCESS
- press 2 to select SECRET CODE
- Enter your new Secret Code

How to check the current Parental Control setting

To see the current Parental Control setting,

- press the MENU button (8) on the remote control
- press 4 to select ACCESS

If you look at menu item 5 PARENTAL CONTROL, you see the factory setting of 18 meaning that all programmes can be viewed without restriction.

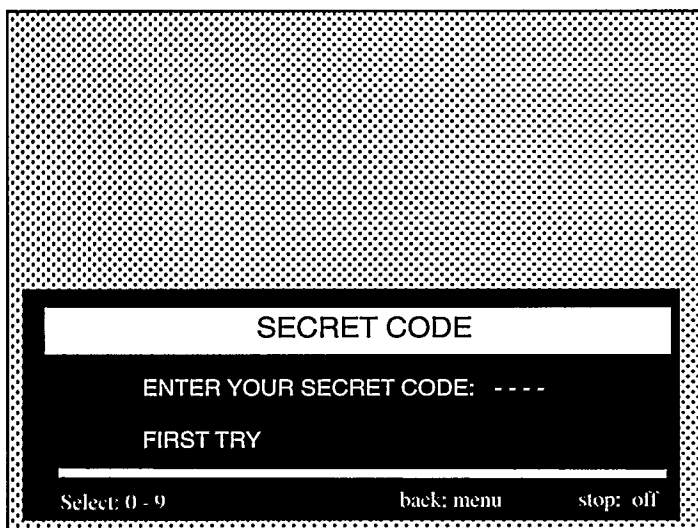

Your Secret Code must have four digits eg 3547.

If you make a mistake at any time press MENU. This will take you back to the previous screen so you can start again. When you have finished, press MENU to return to the previous menu or OFF to return to normal viewing.

Do not change your Secret Code too often - this uses up memory in the EuroCrypt card.

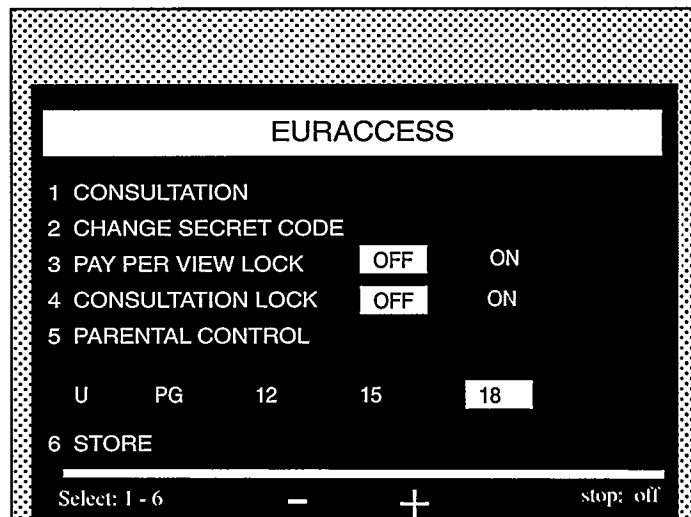

If you wish to use Parental Control you will probably want to change the setting to one of your own choice. Here is how you do it.

How to change and lock the Parental Control setting

Have you entered your own Secret Code (not 0000)? If not, you will see a message at the bottom of the ACCESS menu: CHANGE SECRET CODE TO ACTIVATE LOCKS To do this, see "How to change your Secret Code" above.

Select menu item 5 PARENTAL CONTROL and, when the text has changed to yellow, press the - + key to move through the available settings. Stop on the setting you want - when it is highlighted.

- press 6 STORE
- enter your Secret Code

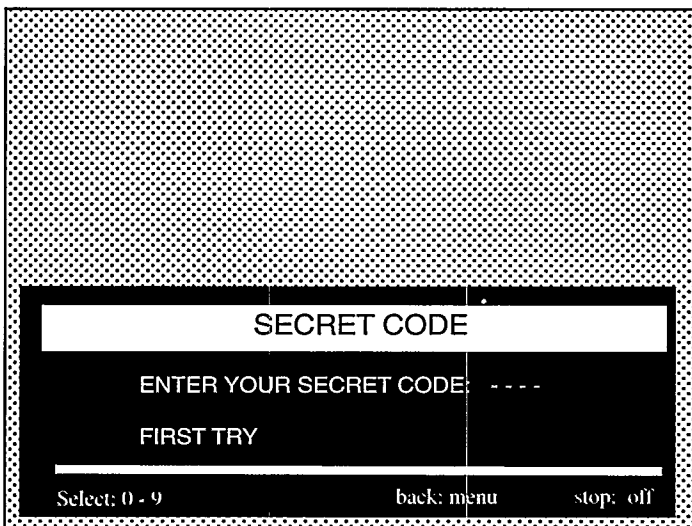

The new Parental Control setting takes effect and cannot be changed unless you enter your Secret Code on request.

Notice that you can always use the - + key to highlight other PARENTAL CONTROL settings, but they do not operate until you STORE, which requires you to first enter your Secret Code. Changing the secret code back to 0000 will cancel all locks.

What is Conditional Access (CA)?

Satellite TV signals can be received in many different areas and countries and are either 'free' or 'subscription'. 'Free' channels can normally be viewed without restriction.

To comply with international copyright requirements, and enable programme providers (the broadcasters of programmes) to obtain payment for subscription channels, a system of **conditional access** has been developed. This uses a process known as encryption.

An encrypted programme will usually appear on your screen as an unrecognisable picture with no sound. You can only view the programme if you are authorised to do so and have a valid EuroCrypt card.

Your Philips STU 901 is fitted as standard with a EuroCrypt card reader (13) to let you view programmes encrypted with the

EuroCrypt conditional access system. Note that some programmes are encrypted with another conditional access system.

How to watch an encrypted programme

If you want to watch a programme encrypted to the EuroCrypt standard, you will first have to contact the programme provider. They will register you as an authorised viewer - sometimes asking payment of a fee - and will provide you with a EuroCrypt card. You insert this into the Smart Card reader* (13) on your Receiver and you can then watch the programme or programmes, for which you have been authorised.

You can leave your EuroCrypt card in the slot at all times but it only works with D2-MAC EuroCrypt programmes. It has no effect on other programmes.

Using a EuroCrypt card

A EuroCrypt card has a small micro-processor built in. This is used by the programme provider to 'tell' the system which programmes you are authorised to watch and, in the case of subscription channels, how long you have paid for.

When you first receive your EuroCrypt card, you will want to enter your own Secret Code to stop others changing your choices (a EuroCrypt card is supplied with the code set at 0000, which means there is no Secret Code). To put in your own code, see "How to change your Secret Code" above.

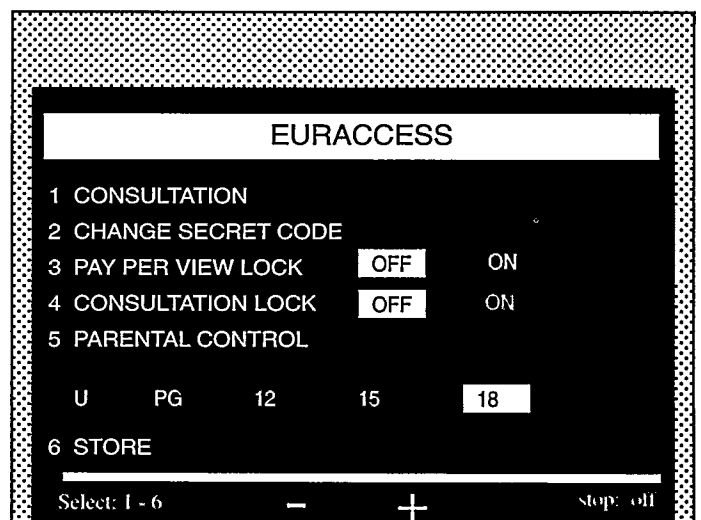
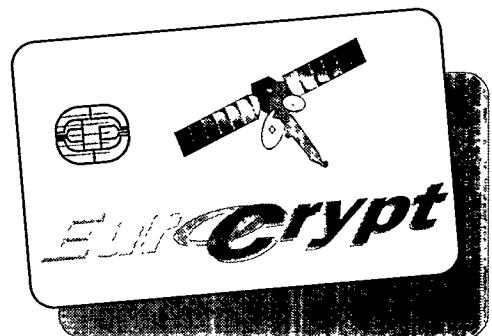

How to use Consultation

- press the MENU button (8) on the remote control
- press 4 to select ACCESS
- press 1 to select CONSULTATION
(wait for the CONSULTATION menu to appear)

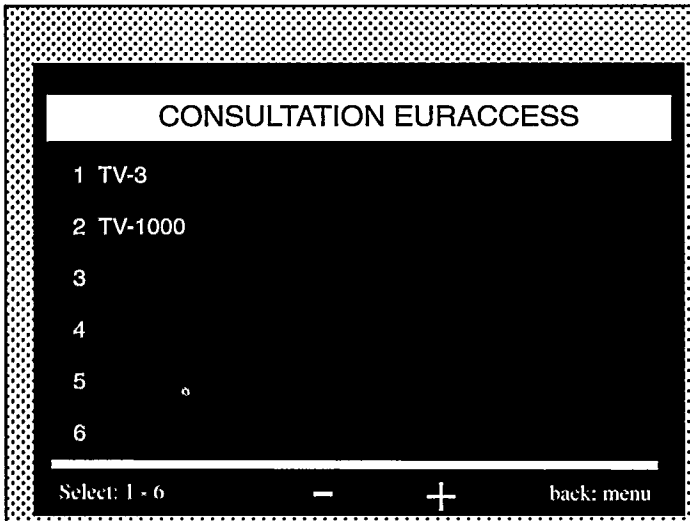

- press a number to select the Programme you wish to consult

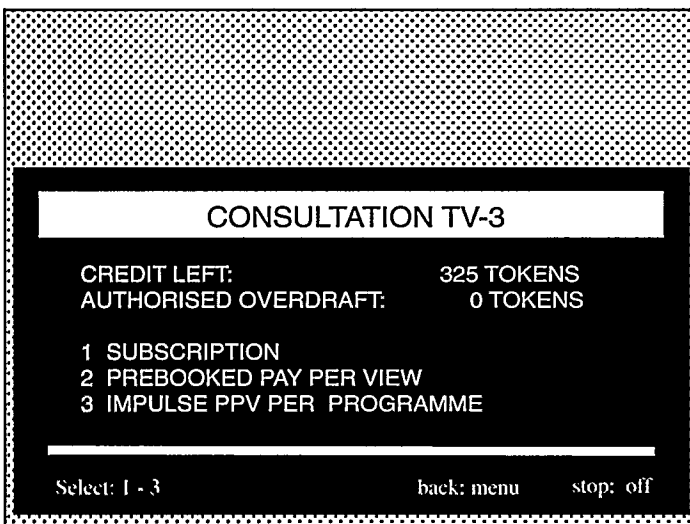

Just below the main title, you see eg.:

CREDIT LEFT: 325TOKENS
AUTHORISED OVERDRAFT 0 TOKENS

This information concerns IMPULSE PPV PER PROGRAM

To see your Subscription details

- press 1 to select SUBSCRIPTION

You will see a screen display like this.
The details will depend on your actual subscription.

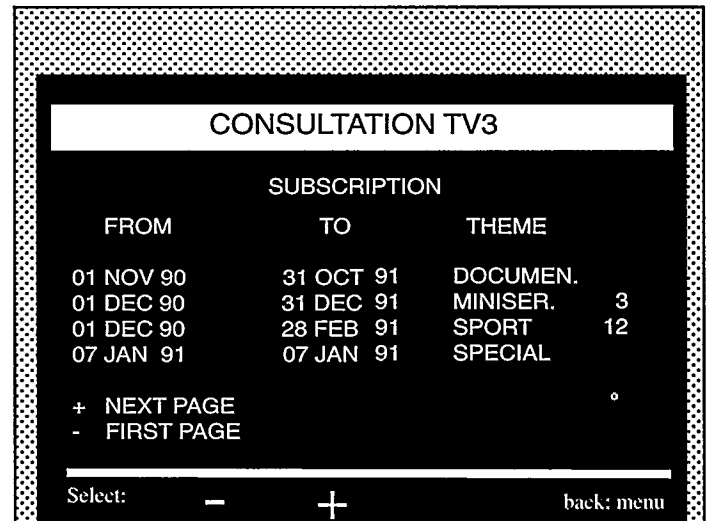

To see Prebooked Pay Per View details

- press 2 to select PREBOOKED PAY PER VIEW
- You will see a screen display like this where the numbers correspond to the programme numbers listed in your TV guide.
The details will depend on your actual subscription.

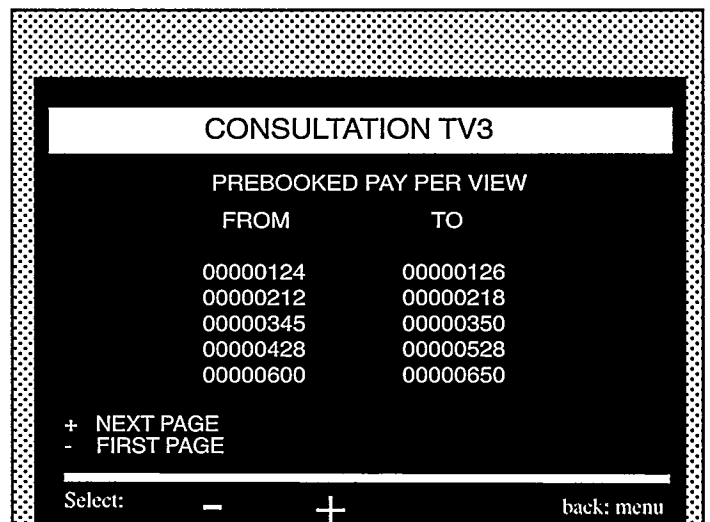

To see Impulse PPV per Program details

- press **3** to select IMPULSE PPV PER PROGRAM

You will see a screen display like this where the CREDIT LEFT shows how many tokens you have left in your EuroCrypt card from your original purchase. AUTHORISED OVERDRAFT shows how many overdraft tokens are available in your EuroCrypt card.

The actual token, programme and price details will depend on your subscription.

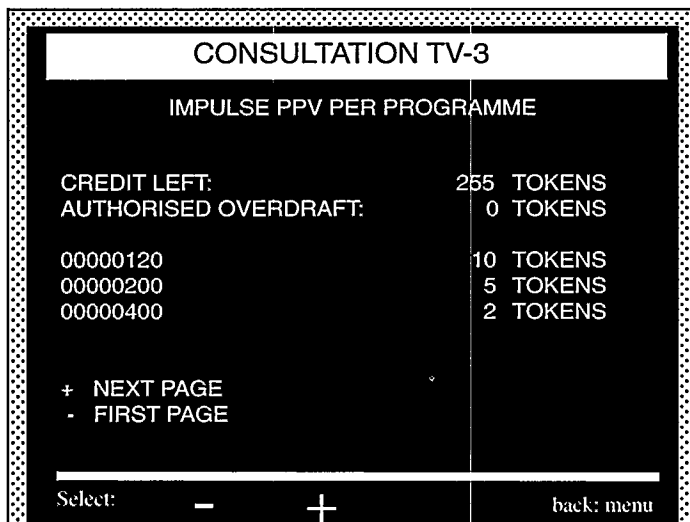

To set the Consultation lock

You may wish to stop others looking at the details on your EuroCrypt card. To do this, proceed as follows:

- press the MENU button (**8**) on the remote control
- press **4** to select ACCESS
- press **4** to select CONSULTATION LOCK
- press - or + to select ON
- press **6** STORE
- enter your Secret Code (which should not be 0000)

Now no-one can look at the details on your EuroCrypt Card unless they first enter your Secret Code.

To set the Pay Per View lock

As an impulse Pay Per View (PPV) subscriber, you may wish to stop others viewing and therefore purchasing the programmes. To do this, proceed as follows:

- press the MENU button (**8**) on the remote control
- press **4** to select ACCESS
- press **3** to select PAY PER VIEW LOCK
- press - or + to select ON
- press **6** STORE
- enter your Secret Code (which should not be 0000)

Now no-one can watch an impulse PPV programme unless they first enter your Secret Code.

To view Impulse Pay Per View programmes

If you are an Impulse Pay Per View (PPV) subscriber, and want to watch a specific programme, proceed as follows:

- select the programme number using the buttons (**6**) on your remote control. You will see the following On-Screen Display:



- press **1** for YES or **2** for NO
- enter your Secret Code (if Pay Per View Lock is ON)

The number of tokens will be deducted from your Credit in the EuroCrypt card and you can watch the programme.

If you have no credits left, you will see the message: OVERDRAFT REACHED

If you have no subscription, you will see the message: NO ACCESS

Renewing your authorisation

When the period for which you have been authorised runs out, you will see a screen message like this: NO ACCESS.

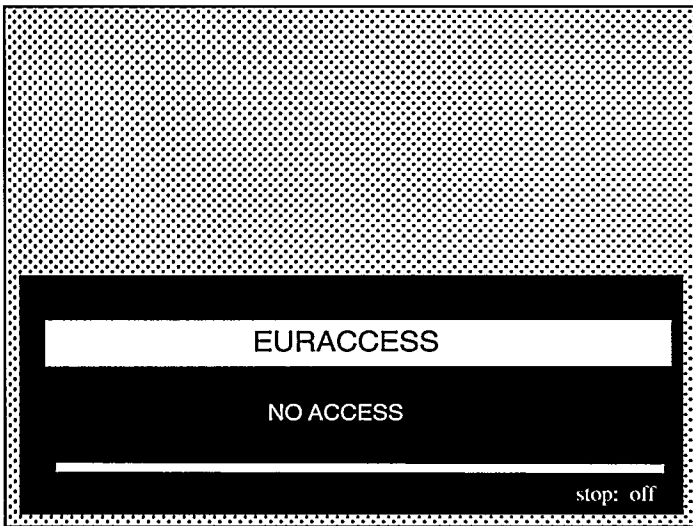

Contact the Programme Provider to arrange a new authorisation.

Open out the rear flap to see how to use the On-Screen-Displays.

Introduction

Your Philips STU 901 is pre-programmed at the factory with station names, numbers etc as well as 'preferences' for sound, language, subtitling, etc. In the following section, you will find out how to change these to suit your individual wishes.

All changes are made using the MENU buttons and the On-Screen-Displays. This makes the procedures fast and easy.

Changing the menu language

The STU 901 is delivered so that the menu items are in the language normally used in your country or area. If you want to change this, proceed as follows.

- press the MENU button (8) on the remote control
- press 7 to select INSTALLATION
- press 1 to select MENU LANGUAGE
- press the number for the language you want
- press MENU OFF

Your new choice of menu language is stored automatically.

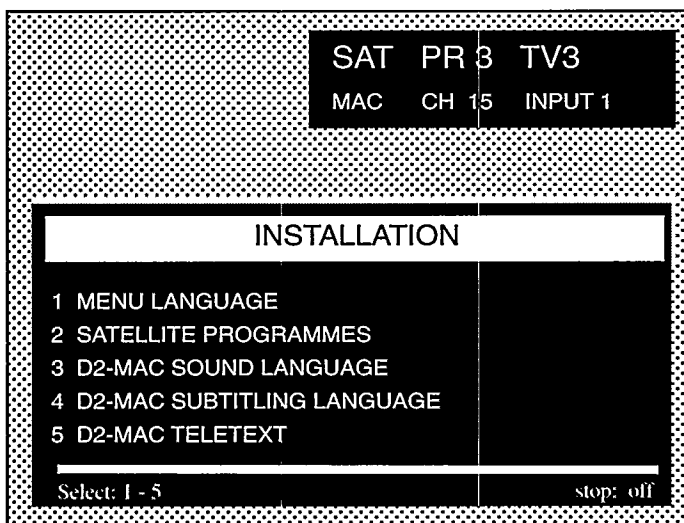

Adjusting the picture

- press the MENU button (8) on the remote control
 - press 1 to select PICTURE.
- Follow the instructions below to change the settings.

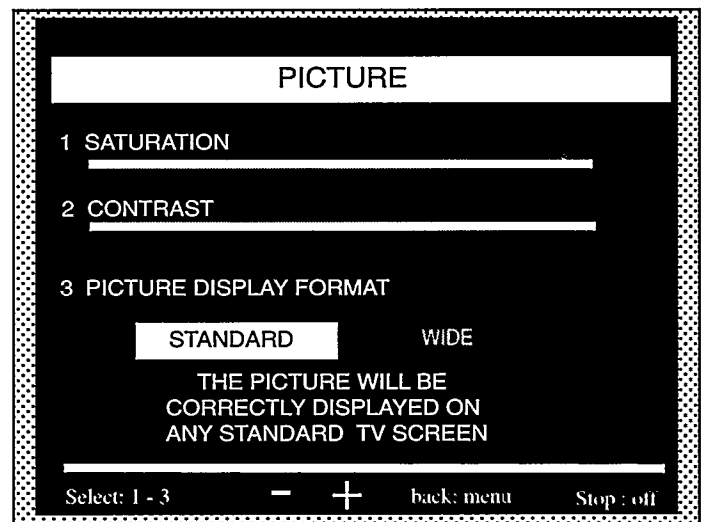

Changing colour saturation and contrast (D2-MAC programmes only)

Colour saturation and contrast have been set to a standard value in the factory. To change them

- press either 1 SATURATION or 2 CONTRAST
- press the - + key of the MENU buttons (8).
The red and blue bars will grow longer or shorter.
- release the - + key when you have the picture you like.

NOTE:

Do not change the Saturation and Contrast settings too far to the left or right - you may get poor recording of programmes on your video recorder.

Changing the picture display format

The TV pictures we are used to seeing use a format which was set more than 50 years ago to match the movie films of the time. Since then, movie screens have grown wider but TV pictures have not.

When you watch a wide-screen movie on a normal TV you either see all the picture but with black bars at top and bottom or you see the picture full-screen but with the sides removed.

Now D2-MAC brings wide-screen pictures to TV and new wide-screen TV sets are appearing on the market. They use a format of 16:9 compared with the 'old' 4:3 format you are used to. If you have one of the new wide-screen sets, you should set the picture display format to WIDE as follows:

- press the MENU button (8) on the remote control
- press 1 to select PICTURE
- press 3 to select PICTURE DISPLAY FORMAT
- use the - + key to highlight WIDE
- press MENU OFF

Make sure your TV set is set to the wide-screen position when receiving wide-screen transmissions.

Changing your preferences for D2-MAC sound

With D2-MAC programmes you can set the language you prefer for the main sound and subtitling. If the broadcaster is transmitting these languages, your STU 901 will automatically select the ones you prefer.

You can select two other languages which you would like if your first choice is not being broadcast. Your Receiver will handle this automatically.

If none of your language preferences are being broadcast, you see and hear the original language of the programme, often called 'Main sound' or 'Background'.

To change your preferences for D2-MAC language sound:

- press the MENU button (8) on the remote control
- press 7 to select INSTALLATION
- press 3 to select D2-MAC SOUND LANGUAGE

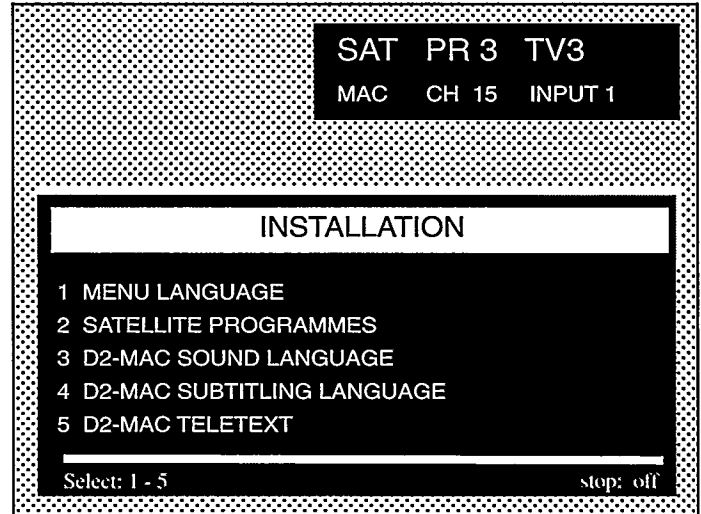

- press 1 for your first priority
- press - + to select the language you want
- press 2 for your second priority
- press - + to select the language you want
- press 3 for your third priority
- press - + to select the language you want
- when you have the selections you want, press MENU
- press 4 to STORE your new selections
- press MENU OFF



Changing your preferences for D2-MAC subtitling

Press the MENU button (8) and select the menu item 7 INSTALLATION.
Press 4 to select D2-MAC Subtitling language. Now you can follow the same procedure as you have used for D2-MAC Sound.

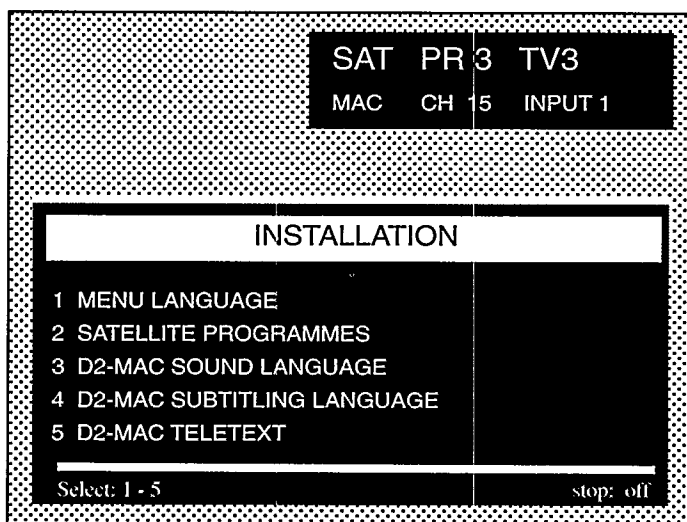

Sound selection with PAL/SECAM programmes

Your programme guide may tell you which languages are available for the programmes you like to watch.

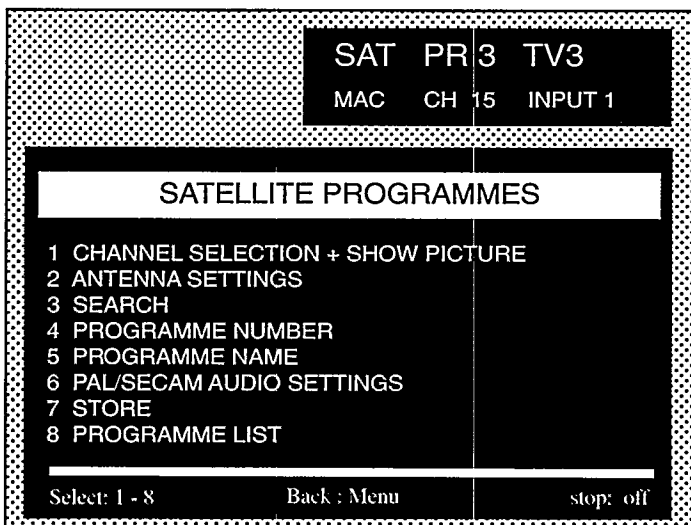

To change the sound settings with PAL and SECAM MONO programmes,

- press the MENU button (8) on the remote control
- press 7 to select INSTALLATION
- press 2 to select SATELLITE PROGRAMMES
- press 6 to select PAL/SECAM AUDIO SETTINGS
- press 1 to select MONO
- press 1 to select TUNE
- press - + until you hear clearly the sound you want
- if necessary, press 2 to select the correct DEVIATION (see the Satellite Programme Guide, or select what sounds the best)
- if necessary, press 3 to select the correct DEEMPHASIS (see the Satellite Programme Guide, or select what sounds the best)
- press MENU twice to return to SATELLITE PROGRAMMES
- if you wish, press 7 to STORE your new settings
- press MENU OFF

To change the sound settings with PAL and SECAM STEREO programmes or multilingual programmes,

- press the MENU button (8) on the remote control
- press 7 to select INSTALLATION
- press 2 to select SATELLITE PROGRAMMES
- press 6 to select PAL/SECAM AUDIO SETTINGS
- press 2 to select STEREO/LANGUAGE/RADIO
- press numbers 0 -9 until you find the sound you want
- press MENU twice to return to SATELLITE PROGRAMMES
- if you wish, press 7 to STORE your new settings
- press MENU OFF

Introduction to Programming

TV stations transmit their programmes on channels. Channel numbers are indicated by two-digit numbers (e.g. CH 09).

Each station can be stored under a programme number (1 to 98). Programme numbers have one or two digits (e.g. PR 7 or PR 17). The factory-set programme numbers can be found in the Satellite Programme Guide delivered with your Receiver.

When searching for stations, you will find that some are broadcasting the new **D2-MAC** signals while others are using the 'old' **PAL/SECAM** signals.

With **D2-MAC** signals, you can obtain information on the programme you are watching by pressing the + key (8) on your remote control. An information block appears at top right of your TV screen. This information block is not available when **PAL/SECAM** signals are being received.

For **PAL/SECAM** signals, the sound may have to be programmed separately. See 'Sound selection with PAL/SECAM programmes' above. So, if you have a good picture but bad sound, just continue programming.

Search for a station...

To find a station not already programmed into your Receiver first check its technical details and make sure your dish is pointing at the right satellite. Then proceed as follows:

- press the MENU button (8) on the remote control
- press 7 to select INSTALLATION
- press 2 to select SATELLITE PROGRAMMES
- press 2 to select ANTENNA SETTINGS
- if necessary, press 1 to select INPUT ANTENNA SELECTION and use + to select INPUT 1 (21) or INPUT 2 (22)
- if necessary, press 4 to select POWER LNC and use - + to select 14 V or 18 V:
 - for a single band LNC select 18 V
 - for dual band LNC's select 14 V for the low band (usually band I, see page 4 of the satellite programme guide) or 18 V for the high band (usually band II)
 - for voltage controlled polarisation dishes (type Marconi), select 14 V for Vertical, or 18 V for Horizontal polarisation
- if necessary, press 2 for SELECT POLARIZATION and use - + to highlight the polarization you need
- press MENU to return to SATELLITE PROGRAMMES
- press 3 to SEARCH. The menu will disappear. The Receiver will search until it finds a station.
MAC programme = menu plus picture
PAL programme = menu only
- select 1 to show picture
- press MENU to go back and see the menu

... or Direct Channel Selection

- press the MENU button (8) on the remote control
- press 7 to select INSTALLATION
- press 2 to select SATELLITE PROGRAMMES
- press 1 to select CHANNEL SELECTION
- enter a number between 01 and 40 (or use - + to change the number)
- press MENU to return to SATELLITE PROGRAMMES menu

Give it a programme number

- when you find the programme you want, press 4 to select PROGRAM NUMBER
- enter a number between 1 and 98 (or use - + to change the number)
- press MENU to return to SATELLITE PROGRAMMES menu

Naming a station

Press 5 to select the programme name menu as shown:

Select in turn the digit buttons 1-5, and after each selection use the - or + button to see all the possible letters of the alphabet, numbers or a space that can be used to give the name to the TV station.

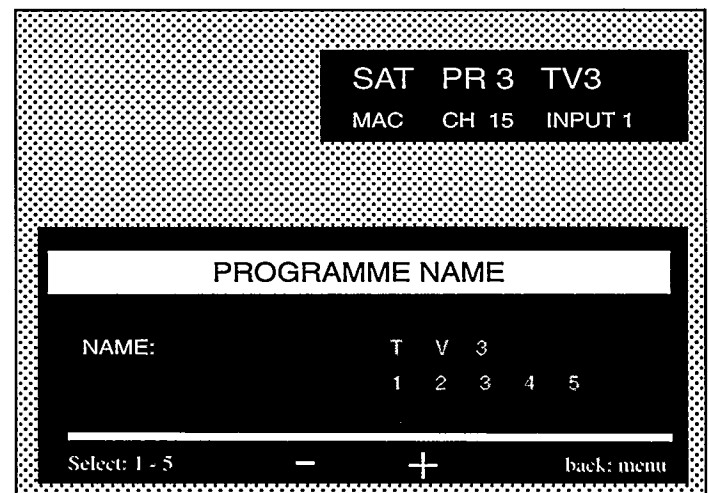

Press the MENU button to return to the satellite programme menu.
Press 7 to STORE the TV station.
Repeat steps for all the required TV stations.

To check the programme list

Press 8 to select programme list.
The following programme list, for example is shown:

PROGRAMME LIST					
NR	NAME	NR	NAME	NR	NAME
01	SCREE	18	RTL R	35	1-B 16
02	RTL +	19	EUROS	36	TV 4
03	TV 3	20	1-B 1	37	RTL +
04	EUROS	21	1-B 2	38	3 SAT
05	LIFES	22	1-B 3	39	SAT 1
06	SAT 1	23	1-B 4	40	1 PLUS
07	T1000	24	1-B 5	41	CANAL
08	SKY 1	25	1-B 6	42	LA 7
09	TCLUB	26	1-B 7	43	EUROM
10	3 SAT	27	1-B 8	44	SPORT
11	FILMN	28	1-B 9	45	CULTU
12	NEWS	29	1-B 10	46	INTER
13	RTL 4	30	1-B 11	47	BBC
14	PRO 7	31	1-B 12	48	RAI
15	MTV	32	1-B 13	49	SAT 1
16	MOVIE	33	1-B 14	50	TELEC
17	SKY R	34	1-B 15	51	3 SAT

Select: - + back: menu

To see the list for programme numbers 51-98, press the + button.

Press the MENU button to return to the satellite programmes menu, or OFF to quit the menus.

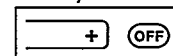

Storing a station

- press 7 to **STORE** your settings
- press 3 to continue searching (see above) or press MENU OFF to exit

NOTES:

- A maximum of 98 stations can be stored in the memory.
- If a bad picture appears it is possible that your dish antenna is not precisely directed at the satellite and needs adjustment.
- Programme numbers (PR) 00 and 99 are reserved for specific functions:
 - 1) On PR 00, D2-MAC signals received from a VCR are processed by the Receiver for replaying on your TV screen. This is the case when your VCR is able to record and playback D2-MAC signals.
 - 2) On PR 99, D2-MAC signals received by your TV are processed by the Receiver for playing on your TV screen. This is the case when you have a MAC-capable TV set.

Using Teletext (D2-MAC only)

Introduction

Your STU 901 Receiver allows you to see Teletext information pages from D2-MAC satellite TV broadcasts - even if your set does not have Teletext.

Switching on Teletext



- Select the programme number for a satellite programme that transmits Teletext.
- Press the  button. Usually the index page (e.g. page 100) can then be seen on the screen. If the screen remains black, no teletext is transmitted.

Selecting a Teletext page

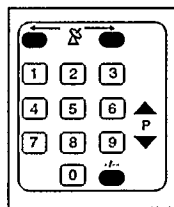

- Press 3 digit buttons (e.g. 6 then 5 then 0 for page 650). This starts then page indicator. When the page indicator is the same as the required page number it stops and the Teletext page is shown on the screen. If the Teletext page you have chosen is not available, then the page indicator continues, until you select a Teletext page that can be found. You may also select pages using the - + buttons.

Press the  button to return to page 100.

To switch off Teletext temporarily

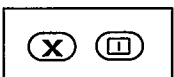



- Press the X button. Only the page number is shown on the screen when the page is updated.
- If you want to switch on Teletext again press the X button.

To select double height text

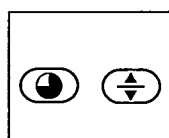
Note: If the Teletext page is updated the top half of the page is automatically selected.

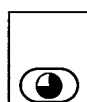
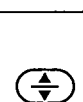

- Press the  button to see the top half of the Teletext page enlarged on the screen.
- Press the  button to see the bottom half of the Teletext page enlarged on the screen.

-If you want to return to normal height text press the  button again.

To show concealed information

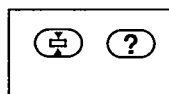

- Some Teletext pages contain quizzes or riddles.
- Press the ? button to show the concealed information.
- Press the ? button again to hide this information.

To stop automatic page changes (of 'rotating' pages)

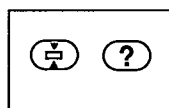

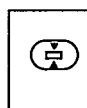

- Some information in Teletext needs more than one page. Each page is shown automatically in sequence.
- Press the  button to stop the page changing automatically.

-Press the  button to return to normal Teletext use.

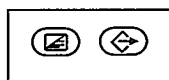
To see Teletext and a TV programme simultaneously (D2-MAC only)



- Press the  button to superimpose teletext over the TV programme.
- Press the  button again to return to normal teletext use.

To quit Teletext



- Press the  button

To store Teletext personal preference pages

You can store up to 20 Teletext pages that you frequently use. Note: Teletext must not be switched on.

- Press MENU button (8) on the remote control
- Press 7 to select INSTALLATION
- Press 5 to select D2-MAC Teletext
- Press 1 to SELECT

If Teletext page numbers have not been previously stored then an empty list is shown:

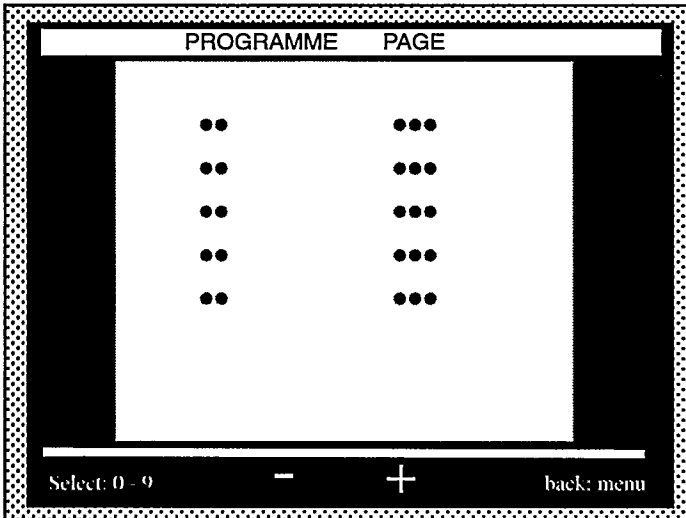

Then,

- (1) Select the programme number (2 digits) for the TV station then the Teletext page number (3 digits). The last selected page is shown in red.
- (2) If you want to select more Teletext pages you can move up or down using the - or + button. Then repeat step (1).

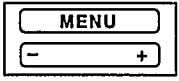

(3) Press the MENU button so that the TXT PAGE NUMBERS menu is shown.

- (4) Press the  button to delete a personal preference page from the list.
- (5) - Press 2 to store.
The complete list of selected Teletext pages is shown in red on the screen until they are stored in the satellite Receiver.
- Press MENU OFF.

GENERAL

RECEPTION

- Multi-standard Satellite Television Receiver for D2-MAC, PAL and SECAM signals
- Remote control of all main functions
- On-Screen-Displays (OSD) for easy operation
- EuroCrypt conditional access system
- D2-MAC Teletext
- Dual Band LNC control

PICTURE QUALITY

- Digital video processing
- Widescreen pictures with an aspect ratio of 16:9, improved resolution and suppression of cross colour effects through MAC transmission
- Compatible with future High Definition transmissions (HD-MAC)
- RGB output for high quality pictures
- S-VHS output

SOUND QUALITY

- Digital HiFi sound with MAC transmissions
- Up to 8 sound channels for different languages
- Ambient/background sound mixable with each transmitted sound
- Separate headphone language selection with MAC transmissions
- Up to 6 audio channels with PAL reception for stereo/multi-lingual/radio reception

OPERATION

- All functions remote controlled
- Operation and Installation completely menu-controlled via On Screen Display (OSD)
- Fluorescent Tube Display for channel/programme indication
- 98 Presets
- Integrated EuroCrypt Conditional Access system
- Integrated EuroCrypt card reader for Conditional Access
- Polarizer setting programmable per preset
- Factory pre-programmed

TECHNICAL SPECIFICATIONS

RECEPTION

Frequency range	: 950 - 1750 MHz
Input level	: -60 to -30 dBm, 75Ω
Audio frequency range (PAL/SECAM)	: 5.5 to 8.5 MHz
Stereo sound carrier frequencies (PAL)	: 7.02 - 7.20 - 7.38
De-emphasis switchable	: 7.56 - 7.74 - 7.92 MHz
	: 50 - 75 μs/J17

SOUND

Frequency response (DIN 45500)	: 20 Hz - 15 kHz
--------------------------------	------------------

VIDEO

Video Output	: 1 Vpp into 75 Ω
Video Bandwidth (D2-MAC)	: 8.4 MHz (-3 dB)
Video Bandwidth (PAL/SECAM)	: 4.8 MHz (-3 dB)

CONNECTIONS

Headphone (6.3 mm jack, front)
 1 RGB Euroconnector for TV
 1 RGB Euroconnector for VCR
 S-VHS output for D2-MAC reception
 2 Satellite antenna inputs (IEC 9.5 mm) with O/14/18 VDC output
 Baseband output (DIN, PAL, de-emphasis)
 Audio outputs left/right (CINCH)
 Terrestrial antenna input 75 Ω coax
 Terrestrial antenna output 75 Ω coax
 Polarizer control (5.6 V, pulse, GND ; click-fit)

MISCELLANEOUS

Operating temperature range	: +5 to +40°C
Mains input	: 220 - 240 V, AC ±10%, 50 Hz
Power consumption	: 45 W (stand-by 7 W)
Weight	: 5 Kg
Dimensions (h x w x d)	: 90 x 420 x 330 mm
Dimensions packaged	: 210 x 550 x 470 mm

ACCESSORIES

- 1 Euroconnector cable
 - 1 Terrestrial antenna cable
 - 1 Male connector for satellite dish antenna Input 1
 - 1 Remote control type RC 5914
- Directions for use with satellite programme guide

FAULT

Receiver does not operate

If the Receiver does not give the desired result when used

If you have any of the faults shown, take the required action and, if this does not achieve the required result,

Cannot select TV programmes when Receiver is switched on.

With some TV sets it may be impossible to select a normal TV programme while the satellite Receiver is switched on. This may be the case if, for example, you have your satellite Receiver connected to your TV by means of an A/V connector cable and you want to make a recording of a satellite programme while watching a normal TV programme.

Poor reception

If you have followed carefully the instructions in Section 2 "HOW TO CONNECT YOUR RECEIVER", you should get good pictures and sound.

Scrolling picture

The picture is not stable, scrolls or disappears and appears all the time.

CAUSE AND ACTION

- check the power connection
- check the satellite dish antenna and/or A/V connections
- check the position of the ANTENNA CONTROL SWITCH (28).
- verify that the batteries of the remote control are not exhausted.
- consult your dealer.

If this occurs, you should press the TV/SAT button (3) on your remote control **once**. Now you can select and watch TV programmes.

If you wish to return to the satellite programmes, press the same TV/SAT button (3) again.

If you have no problem changing TV channels while your satellite Receiver is switched on, you do not need to use the TV/SAT button.

If not, first **check the section 'Adjust the Polarizer' carefully**.

- Check dish position

If this does not improve things, then the problem may be due to objects such as buildings or trees between your dish and the satellite. Ask your dealer for advice.

Do the following:

- press the MENU button (8) on the remote control
- press 7 to select INSTALLATION
- press 2 to select SATELLITE PROGRAMMES
- press 1 to select CHANNEL SELECTION

The menu will disappear. Press - and + once and see if the channel comes in. If not, you may be tuned to a programme with conditional access for which you have no authorisation.

- press MENU to go back to the menu
- press 7 to **STORE your settings**
- press MENU OFF to exit

Repeat this procedure for other programmes if necessary.

Note: If with any of these above mentioned actions you do not achieve the required result, you should consult your dealer.

HOW TO USE THE ON-SCREEN DISPLAYS

You select On-Screen-Displays by pressing the MENU button (8) of your remote control unit. You see the **MAIN MENU** first.

If you then press the number 1 on the numeric keypad (6) of your remote control, you will see a display similar to the one below.

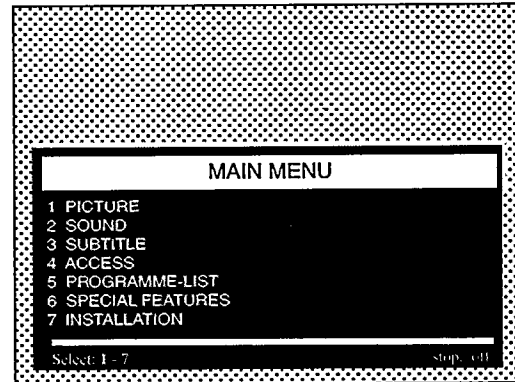



EXAMPLE

Title bar

Select the menu item you want by pressing its number on the remote control keypad (6). The selected menu item will change colour from white to yellow.

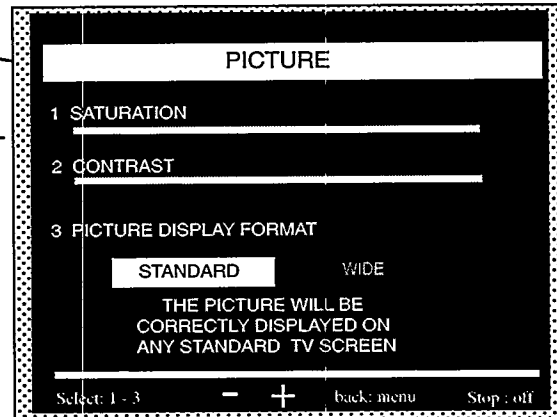
Shows you how to select the items in the menu above - by pressing numbers on the remote control keypad (6).



You select options like **STANDARD** or **WIDE** in the menu above by first pressing the number 3 on the remote control keypad (6), then pressing the  key of the menu buttons (8).

You can also use the  key to change the Saturation and Contrast after you select menu items 1 and 2.

When you see the **stop:off** indication at bottom right, you can switch off the On-Screen-Display and return to normal satellite TV viewing. Press the OFF button of the MENU controls (8).

When you see **back:menu**, you can return to the previous menu by pressing the MENU button (8).

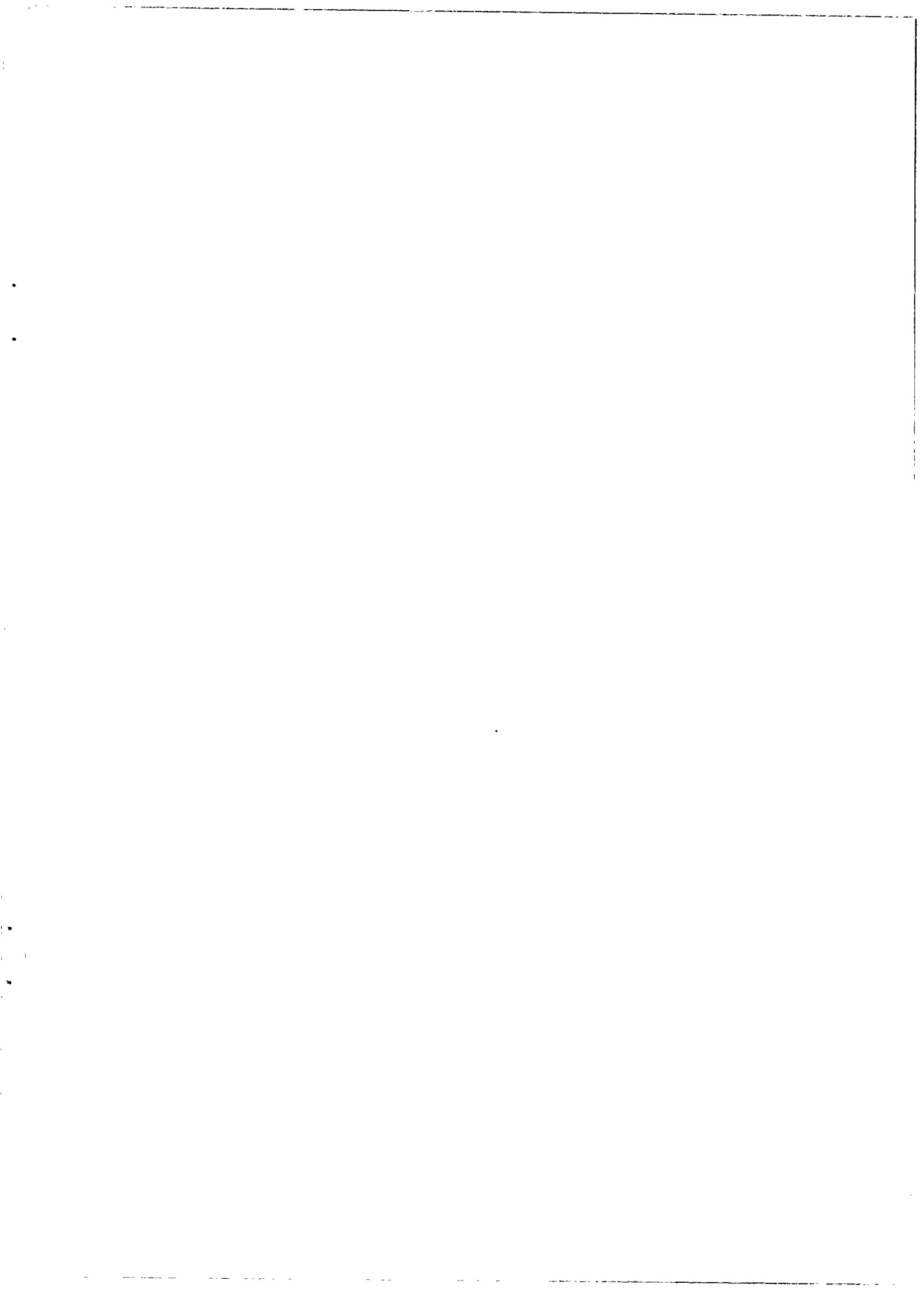

GB IDENTITTY CARD

This card, together with the terms of guarantee (to be provided by your dealer), forms the full certificate of guarantee for this appliance.

D GERÄTE
KENNKARTE

Diese Karte ist, zusammen mit den Garantiebestimmungen, die Ihr Händler Ihnen aushändig, Ihr Garantieschein für dieses Gerät.

F CARTE
D'IDENTIFICATION

Assocée aux conditions de garantie (qui vous sont remises par le revendeur), cette carte constitue le certificat de garantie de cet appareil.

NL IDENTIFICATIEKAART

Deze kaart vormt, samen met de garantievoorwaarden (welke door uw dealer verstrekt worden), het garantiebewijs voor dit apparaat.

I CARTE
D'IDENTIFICAZIONE

Questa cartolina rappresenta insieme alle condizioni di garanzia (da consegnare dal vostro rivenditore) il documento di garanzia per questo apparecchio.

E TARJETA DE
IDENTIFICACION

La garantía de este aparato se compone de esta tarjeta y de las condiciones de garantía que le entregará su concesionario.

P CARTAO DE
IDENTIFICAÇÃO

Este cartao, em conjunto com as condições de garantia em vigor (explicadas pelo seu vendedor) constituem o certificado de garantia do seu aparelho.

DK I.D. KORT

Dette kort, udfyldt af Deres forhandler, er tilstækkelig garantidokumentation for dette apparat.

N IDENTIFIKASJOSKORT

Dette kort, sammen med garanti betingelsene (som De får av forhandleren) utgjør garanti beviset for dette apparat.

S IDENTIFIERINGSKORT

Dette Kort tillsammans med garantivillkoren, som Du får av radiohandlaren, utgör ett fullständigt garanti bevis för denna produkt.

SF TUNNISTUSKORTTI

Tämän laitteen takuutodistus muodostuu tasta kortista ja takuuhdoista (jälleenmyyjä antaa rukaan).

PHILIPS



B